



**ECOPOINT II**

links  
left

ADR Zone 2

IP 56K

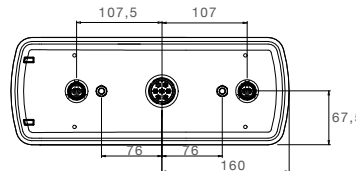
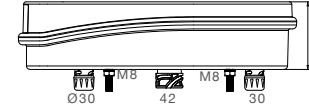
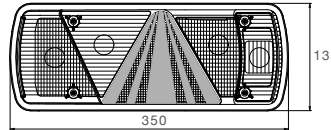

Blinklicht Direction indicator	Rücklicht Tail light	Bremslicht Stop light	Nebelschlusslicht Fog light
Rückfahrlicht Reverse light	Dreieckrückstrahler Triangle reflector	Seitenmarkierungslicht + Reflektor Sidemarker light + reflector	

BEST. NR	PART NO		←	→			ZUSATZ ADD ON	ANSCHLUSS CONNECTOR
25-2800-001	1/6	●				24V		7 pol. ASS2.1 7 pin ASS2.1 ♂
25-2800-451	1/6	●			 	24V		7 pol. ASS2 7 pin ASS2 ♂
25-2800-501	1/6	●				24V		7 pol. ASS2 7 pin ASS2 ♂
25-2800-511	1/6	●				24V		7 pol. ASS2 7 pin ASS2 ♂  2 x 2 pol. ASS2 2 x 2 pin ASS2
25-2800-521	1/6	●				24V		7 pol. ASS2 7 pin ASS2 ♂  2 x 2 pol. ASS2 2 x 2 pin ASS2
25-2801-501	1/6	●				24V		7 pol. ASS2 7 pin ASS2 ♂
25-2860-001	1/6	●				24V		7 pol. ASS2.1 7 pin ASS2.1 ♂
25-2801-701	1/6	●			 	24V		7 pol. ASS2.1 7 pin ASS2.1 ♂
25-2860-701	1/8	●			 	24V	 	7 pol. ASS2.1 7 pin ASS2.1 ♂
25-2880-521	1/6	●				24V		7 pol. AMP 7 pin AMP ♂  2 x 2 pol. Superseal 2 x 2 pin Superseal
25-2860-041	1/8	●				24V	   	7 pol. ASS2.1 7 pin ASS2.1 ♂
25-2860-701	1/8	●			 	24V	   	7 pol. ASS2.1 7 pin ASS2.1 ♂



**ECOPOINT II**

rechts  
right

ADR  
Zone 2

IP 56K

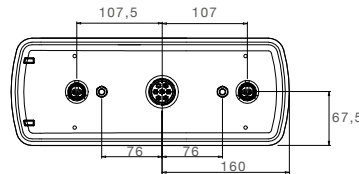
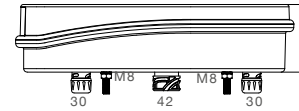
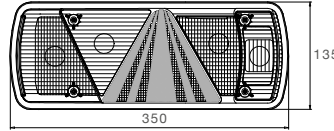

Blinklicht Direction indicator	Rücklicht Tail light	Bremslicht Stop light	Nebelschlusslicht Fog light
Rückfahrlicht Reverse light	Dreieckrückstrahler Triangle reflector	Seitenmarkierungslicht + Reflektor Sidemarker light + reflector	

BEST. NR	PART NO		←	→			ZUSATZ ADD ON	ANSCHLUSS CONNECTOR
25-2900-001	1/6			●		24V		7 pol. ASS2.1 7 pin ASS2.1
25-2900-451	1/6			●		24V		7 pol. ASS2 7 pin ASS2
25-2900-501	1/6			●		24V		7 pol. ASS2 7 pin ASS2
25-2900-511	1/6			●		24V		7 pol. ASS2 7 pin ASS2
25-2900-521	1/6			●		24V		7 pol. ASS2 7 pin ASS2
25-2901-501	1/6			●		24V		7 pol. ASS2 7 pin ASS2
25-2901-551	1/-			●		24V		7 pol. ASS2.1 7 pin ASS2.1
25-2960-001	1/6			●		24V		7 pol. ASS2.1 7 pin ASS2.1
25-2901-701	1/6			●		24V		7 pol. ASS2.1 7 pin ASS2.1
25-2960-701	1/8			●		24V		7 pol. ASS2.1 7 pin ASS2.1
25-2980-521	1/6			●		24V		7 pol. AMP 7 pin AMP
25-2960-041	1/8			●		24V		7 pol. ASS2.1 7 pin ASS2.1
25-2960-701	1/8			●		24V		7 pol. ASS2.1 7 pin ASS2.1



**ECOPOINT II**

links mit Umrissarm  
left with end outline marker

ADR Zone 2 IP 56K

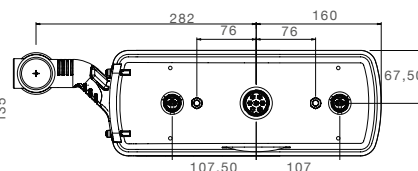
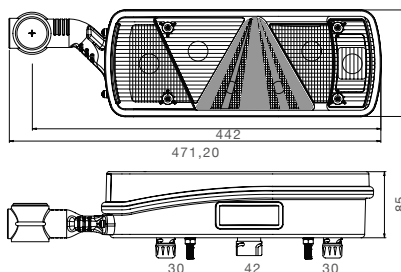

Blinklicht Direction indicator	Rücklicht Tail light	Bremslicht Stop light	Nebelschlusslicht Fog light
Rückfahrlicht Reverse light	Dreieckrückstrahler Triangle reflector	Seitenmarkierungslicht + Reflektor Sidemarker light + reflector	

BEST. NR	PART NO	Box	←	→	Light	V	Hand	ZUSATZ ADD ON	ANSCHLUSS CONNECTOR	
25-2810-511	1/-	●			Light	24V	Light		7 pol. ASS2 7 pin ASS2 ♂	2 x 2 pol. ASS2 2 x 2 pin ASS2
25-2811-501	1/8	●			Light	24V	Light		7 pol. ASS2 7 pin ASS2 ♂	
25-2870-401	1/-	●			Light	24V	Light		7 pol. ASS2.1 7 pin ASS2.1 ♂	
25-2810-501	1/8	●			Light	24V	Light		7 pol. ASS2 7 pin ASS2 ♂	
25-2831-501	1/6	●			Light	24V	lang long		7 pol. ASS2.1 7 pin ASS2.1 ♂	2 x 2 pol. ASS2 2 x 2 pin ASS2
25-2832-501	1/6	●			Light	24V	lang long		7 pol. ASS2.1 7 pin ASS2.1 ♂	
25-2810-451	1/-	●			LED	24V	lang long		7 pol. ASS2.1 7 pin ASS2.1 ♂	
25-2820-741	1/-	●			LED	24V	lang long		7 pol. ASS2.1 7 pin ASS2.1 ♂	2 x 2 pol. ASS2 2 x 2 pin ASS2
25-2820-501	1/8	●			Light	24V	LED		7 pol. ASS2 7 pin ASS2 ♂	
25-2820-541	1/8	●			Light	24V	LED		7 pol. ASS2.1 7 pin ASS2.1 ♂	2 x 2 pol. ASS2 2 x 2 pin ASS2
25-2880-531	1/8	●			Light	24V	LED		7 pol. AMP 7 pin AMP ♂	2 x 2 pol. Superseal 2 x 2 pin Superseal



**ECOPOINT II**

rechts mit Umrissarm  
right with end outline marker

ADR Zone 2 IP 56K

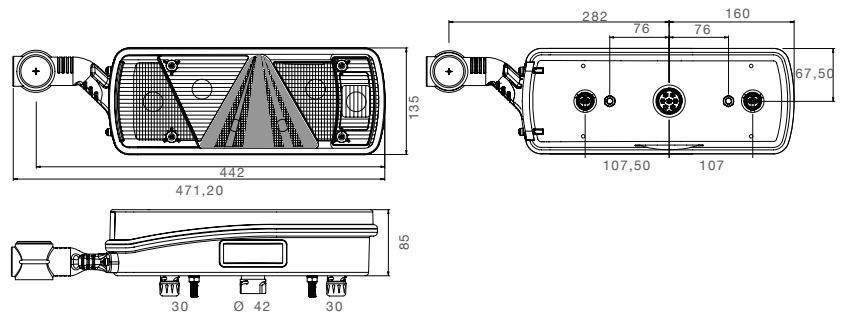

Blinklicht Direction indicator	Rücklicht Tail light	Bremslicht Stop light	Nebelschlusslicht Fog light
Rückfahrlicht Reverse light	Dreieckrückstrahler Triangle reflector	Seitenmarkierungslicht + Reflektor Sidemarker light + reflector	

BEST. NR	PART NO	←	→	💡	⚡	👉	ZUSATZ	ANSCHLUSS
							ADD ON	CONNECTOR
25-2910-511	1/-	●		💡	24V	💡		7 pol. ASS2 7 pin ASS2
25-2910-551	1/-	●		💡	24V	💡		7 pol. ASS2.1 7 pin ASS2.1
25-2911-501	1/8	●		💡	24V	💡		7 pol. ASS2 7 pin ASS2
25-2911-551	1/-	●		💡	24V	💡		7 pol. ASS2.1 7 pin ASS2.1
25-2970-401	1/-	●		💡	24V	💡		7 pol. ASS2.1 7 pin ASS2.1
25-2910-451	1/-	●		LED	24V	lang long		7 pol. ASS2.1 7 pin ASS2.1
25-2931-501	1/6	●		💡	24V	lang long		7 pol. ASS2.1 7 pin ASS2.1
25-2920-741	1/-	●		LED	24V	lang long		7 pol. ASS2.1 7 pin ASS2.1
25-2932-501	1/6	●		💡	24V	lang long		7 pol. ASS2 7 pin ASS2
25-2920-501	1/8	●		💡	24V	LED		7 pol. ASS2 7 pin ASS2
25-2920-541	1/8	●		💡	24V	LED		7 pol. ASS2.1 7 pin ASS2.1
25-2980-531	1/8	●		💡	24V	LED		7 pol. AMP 7 pin AMP
25-2910-501	1/8	●		💡	24V	💡		7 pol. ASS2 7 pin ASS2



## ECOPOINT II

ZUBEHÖR / ACCESSORIES

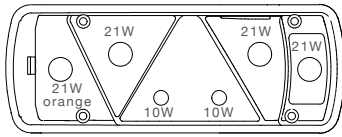

### 1 Lichtscheibe | lens

- (a) links  
left..... 18-8528-002
- rechts  
right ..... 18-8529-002
- (b) links ohne Dreieck  
left without triangle ..... 18-8526-002
- rechts ohne Dreieck  
right without triangle .... 18-8527-002

### 2 LED Einsätze | LED inserts

- (a) Blinklicht links <sup>24V</sup>  
direction indicator left <sup>24V</sup>  
..... 12-1522-154
- Blinklicht rechts <sup>24V</sup>  
direction indicator right <sup>24V</sup>  
..... 12-1526-154
- (b) Rückfahrlicht links <sup>24V</sup>  
reverse left <sup>24V</sup>  
..... 12-1522-144
- Rückfahrlicht rechts <sup>24V</sup>  
reverse right <sup>24V</sup>  
..... 12-1526-144

- (c) Nebelschlusslicht links / rechts <sup>24V</sup>  
fog left / right <sup>24V</sup>  
..... 12-1526-164
- (d) Rücklicht und Bremslicht links <sup>24V</sup>  
tail light and stop light left <sup>24V</sup>  
..... 12-1528-001
- Rücklicht und Bremslicht rechts <sup>24V</sup>  
tail light and stop light right <sup>24V</sup>  
..... 12-1529-001

### 3 Relais

- (a) Rückfahrwarner <sup>24V</sup>  
reverse alarm <sup>24V</sup>  
..... 12-3922-004
- (b) SMCG Steuerung für Seitenmarkierungsleuchten  
SMCG side marker control gear  
..... 12-3970-584

### 4 Schutzhaube | protection cap

- ..... 15-5277-004



**ECOPOINT II**

ZUBEHÖR / ACCESSORIES



**5 Umrissarm Glühlampe | outline marker bulb**

- (a) links kurz  
left short..... 31-3303-024
- rechts kurz  
right short ..... 31-3302-024
- (b) links lang  
links long ..... 31-3303-034
- rechts lang  
rechts long..... 31-3302-034

**6 Lichtscheibe Umrissarm | lens outline marker**  
..... 18-8141-004

**7 Umrissarm LED | outline marker LED**

- a) links kurz  
left short..... 31-3303-044
- rechts kurz  
right short ..... 31-3302-044
- b) links lang  
links long ..... 31-3303-104
- rechts lang  
rechts long..... 31-3302-104

**8 ASS1 & ASS2 Verbinder | ASS1 & ASS2 connector**

- (a) 2 pol. weiblich  
2 pin female ..... 13-5626-401
- (b) 7 pol. weiblich  
7 pin female ..... 13-5626-631
- (c) Verschlusskappe  
closed connection ..... 15-5623-304

**9 Superseal Verbinder | Superseal connector**

- 2 pol. weiblich  
2 pin female ..... 15-7002-044

**10 AMP Verbinder | AMP connector**

- 7 pol. weiblich  
7 pin female ..... 15-7002-024

**Glühlampe | bulb**

- 24V 21W orange ..... 16-6321-617
- 24V 21W ..... 16-6321-037
- 24V 10W ..... 16-6310-027
- 24V 4W ..... 16-6304-027